

### Description

The AH5794 is a single chip solution for driving single-coil brushless direct current (BLDC) fans and motors. The integrated full-bridge driver output stage uses soft switching to minimize audible switching noise and electromagnetic interference (EMI) providing a low noise solution.

Low operating voltage down to 1.8V allows motor speed to be controlled by varying the supply voltage.

To help protect the motor coil, the AH5794 provides Rotor Lock Protection which shuts down the output drive if rotor lock is detected. The device automatically re-starts when the rotor lock is removed. Over temperature shutdown provides thermal protection for the device.

A Tachometer output is provided by open-drain Frequency Generator (FG) Pin which allows external interface to monitor motor rotation or speed. The FG output is the magnetic change frequency.

The AH5794 is available in space saving and low profile TSOT26 and U-DFN2020C-6 packages.

### Features

- Supports single-coil full-wave BLDC fan drivers
- Built-in Hall sensor and input amplifier
- Operating voltage: 1.8V to 6V
- $V_{DD}$  voltage speed control
- Soft switching for low noise DC fan motor applications
- Rotor Lock Protection (Lock detection, output shutdown and automatic re-start)
- Thermal protection
- Tachometer (FG) output
- No external timing capacitor - Reduces the numbers of external components required
- Low profile package: TSOT26 and U-DFN2020C-6
- Halogen and Antimony free "Green" packages.
- Lead Free Finish/ RoHS Compliant

### Pin Assignments

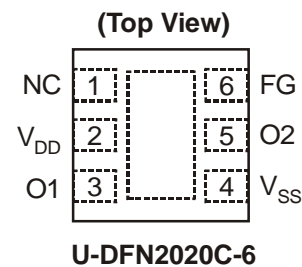
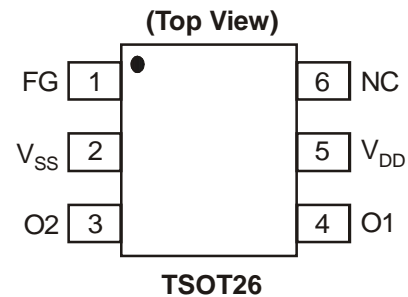

### Applications

- 3V/ 3.3V/ 5V BLDC Cooling Fans
- Netbook/ Notebook BLDC fans
- Instruments cooling fans
- Low Voltage/ Low Power BLDC Motors

**Typical Application Circuit**

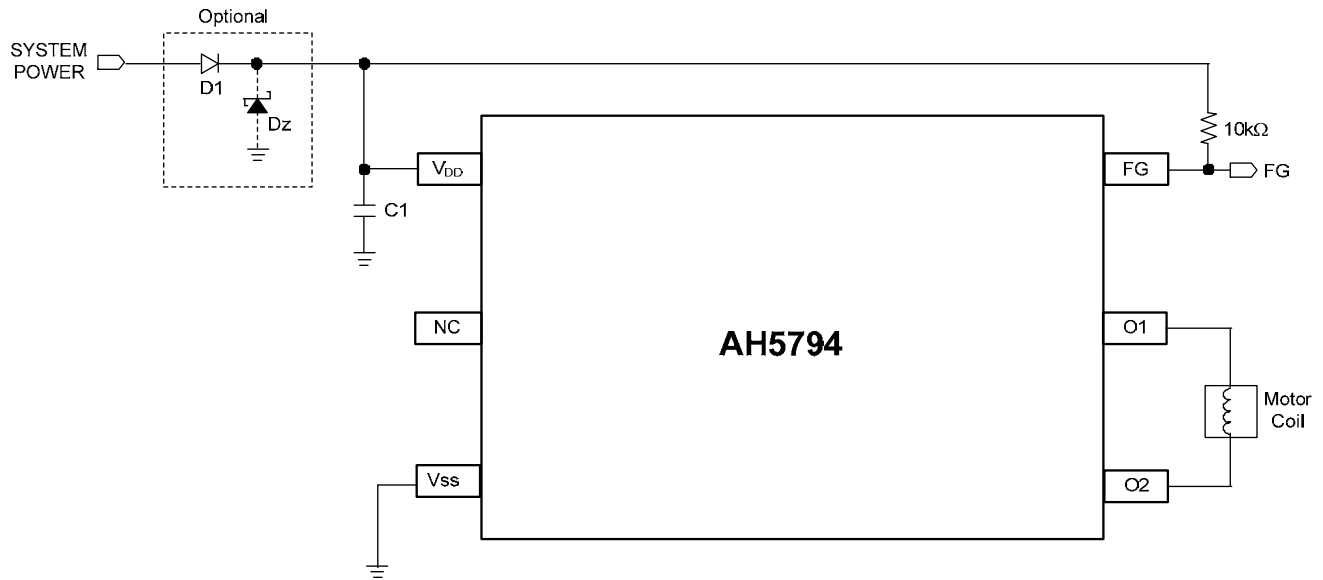

**Pin Descriptions**

Pin Name	Description
V <sub>DD</sub>	Power supply pin
V <sub>SS</sub>	Ground pin
O1	Output driving & sinking pin
O2	Output driving & sinking pin
NC	No connection
FG	Frequency generator (Note 1)

Notes: 1. The FG output is the same as the magnetic change frequency.

**Functional Block Diagram (Note 2)**

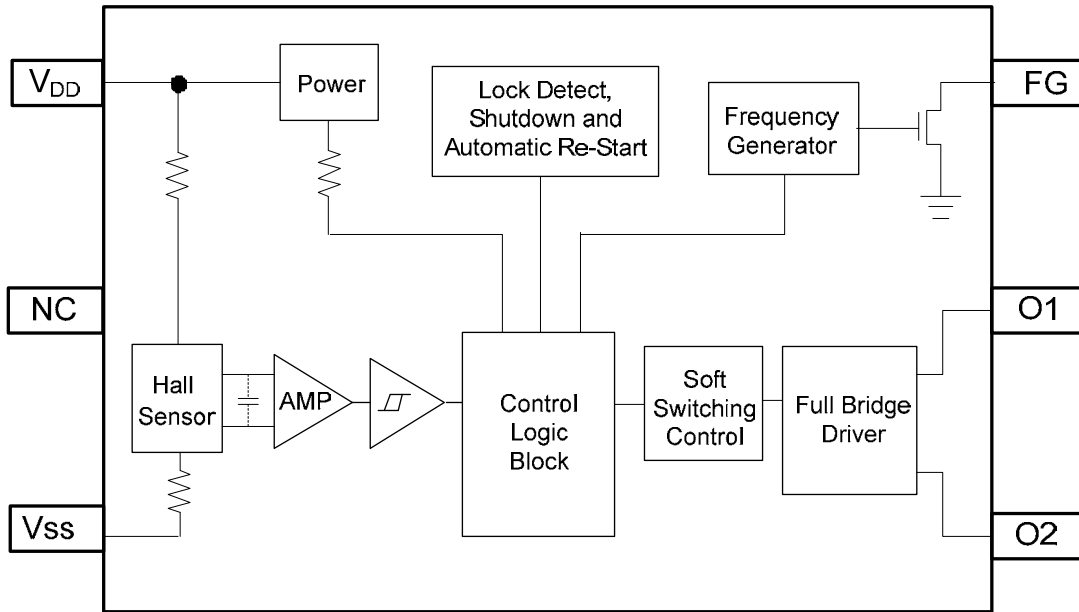

Notes: 2.The AH5794 has an open-drain tachometer FG output that follows the magnetic change frequency. Typically a pull-up resistor of 10kΩ is recommended from FG pin to the supply voltage.

### Absolute Maximum Ratings ( $T_A = 25^\circ\text{C}$ , unless otherwise noted, Note 3)

Symbol	Characteristics	Values	Unit
$V_{DD}$	Supply Voltage	7	V
$I_{O(PEAK)}$	Maximum Output Current (Peak)	1000	mA
$P_D$	Power Dissipation	TSOT26	650
		U-DFN2020C-6	750 (Note 4)
$T_{ST}$	Storage Temperature Range	-65 ~ +150	$^\circ\text{C}$
ESD HBM	Human Body Model ESD Protection	4	kV

- Notes:
- Stresses greater than the 'Absolute Maximum Ratings' specified above, may cause permanent damage to the device. These are stress ratings only; functional operation of the device at these or any other conditions exceeding those indicated in this specification is not implied. Device reliability may be affected by exposure to absolute maximum rating conditions for extended periods of time
  - U-DFN2020C-6 exposed pad soldered to minimum recommended landing pads (see Package Outline Dimension section) on a two-layer 2oz. copper FR4 PCB (1.6mm thickness) with no thermal vias in exposed PADS or any copper flood connecting to the landing pattern of the exposed pad.

### Recommended Operating Conditions ( $T_A = 25^\circ\text{C}$ )

Symbol	Parameter	Conditions	Min	Max	Unit
$V_{DD}$	Supply Voltage at $V_{DD}$ pin	DC supply speed control mode	1.8	6.0	V
$T_A$	Operating Ambient Temperature Range	Operating	-40	+105	$^\circ\text{C}$

### Electrical Characteristics ( $T_A = 25^\circ\text{C}$ , $V_{DD} = 5\text{V}$ )

Symbol	Characteristics	Conditions	Min	Typ.	Max	Unit
$I_{DD}$	Supply Current	No Load	-	2.2	-	mA
$V_{OH}$	Output Voltage High	$I_{OUT} = 300\text{mA}$	4.70	4.88	-	V
		$I_{OUT} = 500\text{mA}$	4.5	4.8	-	V
$V_{OL}$	Output Voltage Low	$I_{OUT} = 300\text{mA}$	-	0.12	0.3	V
		$I_{OUT} = 500\text{mA}$	-	0.2	0.5	V
$V_{OH} + V_{OL}$	Output voltage of N- and PMOS combined	$I_{OUT} = 300\text{mA}$		0.3	0.5	V
		$I_{OUT} = 500\text{mA}$		0.5		V
$T_{SW}$	Output Switching Slope Duration	17 $\Omega$ load on O1/O2	-	200	-	$\mu\text{s}$
$I_{LEAK}$	FG Output Leakage Current		-	-	5	$\mu\text{A}$
$V_{FGOL}$	FG Output Voltage Low	$I_{FG} = 5\text{mA}$	-	-	0.4	V
$T_{ON}$	On Time		350	500	650	ms
$R_{DR}$	Duty Ratio	$T_{OFF} / T_{ON}$	-	10	-	
$T_{J\_SDN\_TH}$	IC junction temperature thermal shutdown threshold			175		$^\circ\text{C}$
$T_{J\_SDN\_HYST}$	IC junction temperature thermal shutdown hysteresis			25		$^\circ\text{C}$

**Magnetic Characteristics** ( $T_A = 25^\circ\text{C}$ ,  $V_{DD} = 1.8\text{V to } 6\text{V}$ , Note 5)

(1mT = 10 G)

Symbol	Parameter	Min	Typ.	Max	Unit
$B_{OP}$	Operate Point	10	25	50	Gauss
$B_{RP}$	Release Point	-50	-25	-10	
$B_{hy}$	Hysteresis	-	50	-	

Notes: 5. Magnetic characteristics may vary with supply voltage, operating temperature and after soldering.

NEW PRODUCT

**Operating Characteristics**

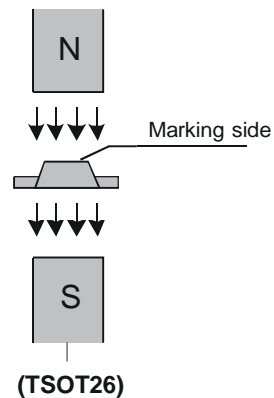
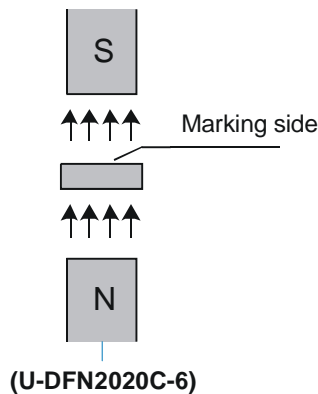
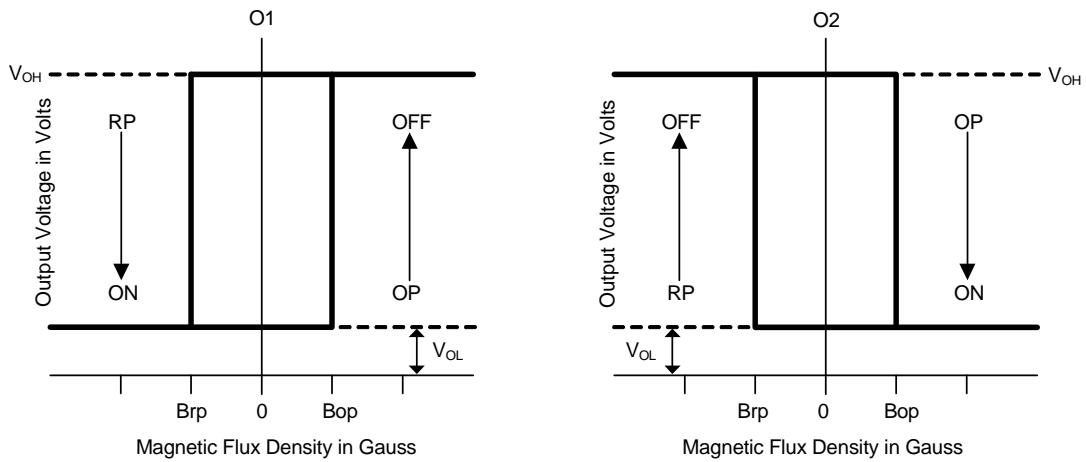

**Operating Characteristics (Note 6, 7, 8 and 9)**

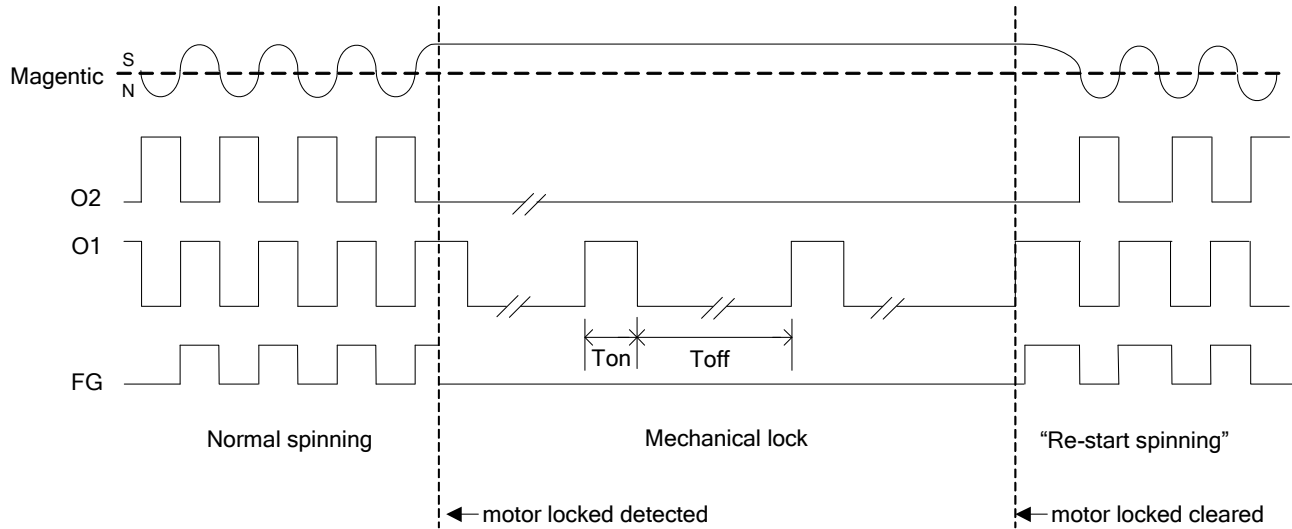

**Truth Table**

O1	O2	FG
L	H	L
H	L	H
L	L	X (Note 9)

- Notes:
- In "Normal spinning, the FG changes its state at each edge of O1.
  - When the motor locks with South pole at the Hall element, O2 is kept on "L" and O1 is a clock with Ton/Toff ratio.  
When motor locks with North pole at the Hall element, O1 is kept on "L", O2 is a clock with Ton/Toff ratio.
  - When "Re-start spinning" occurs, the motor speed ramps up to the "Normal Spinning" speed from zero.  
Speed ramp-up profile depends on motor characteristics.
  - X: H or L depends on magnetic pole North or South

## Application Note

### Motor Speed Control

#### DC Supply Voltage ( $V_{DD}$ ) Speed Control

Motor speed can be controlled by varying the  $V_{DD}$  supply voltage between 1.8V to 6V.

With 5V nominal motor, changing  $V_{DD}$  voltage between 5V to 1.8V, speed can be controlled from 100% to 36% typically.

#### Soft Switching

AH5794 uses soft switching of the motor coil current during commutation for to minimize audible switching noise and electromagnetic interference (EMI) to provide a low noise solution.

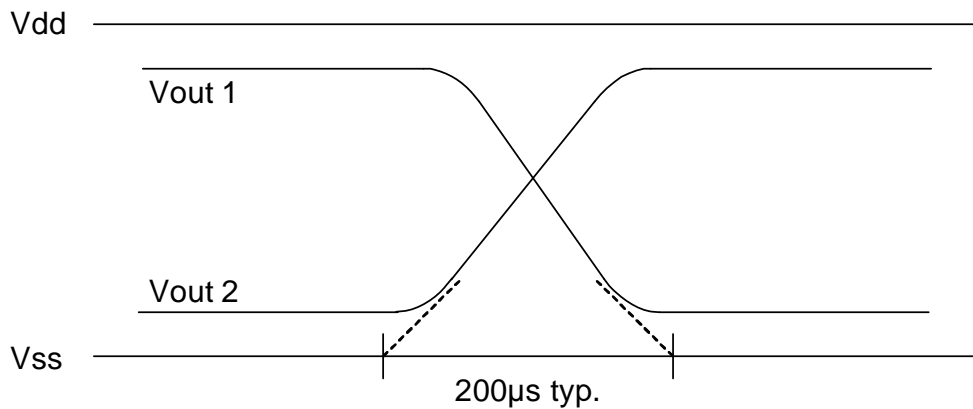

**Thermal Performance Characteristics**

**(1) Package type: TSOT26**

<b>T<sub>A</sub> (°C)</b>	<b>25</b>	<b>50</b>	<b>60</b>	<b>70</b>	<b>75</b>	<b>80</b>	<b>85</b>	<b>90</b>	<b>95</b>	<b>100</b>
P <sub>D</sub> (mW)	651	521	469	417	391	365	339	313	286	260
<b>T<sub>A</sub> (°C)</b>	<b>105</b>	<b>110</b>	<b>115</b>	<b>120</b>	<b>125</b>	<b>130</b>	<b>135</b>	<b>140</b>	<b>145</b>	<b>150</b>
P <sub>D</sub> (mW)	234	208	182	156	130	104	78	52	26	0

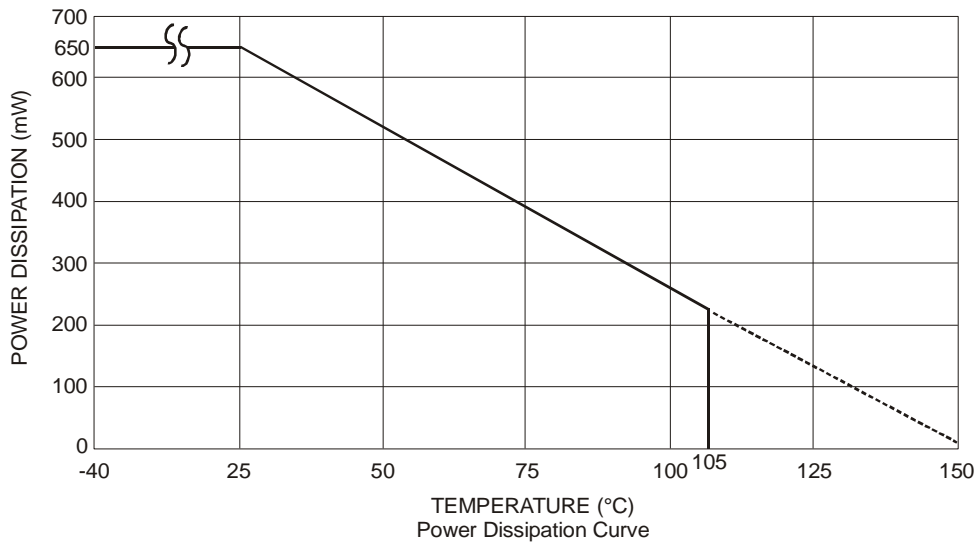



**Thermal Performance Characteristics (cont.)**

**(2) Package type: U-DFN2020C-6 (Note 10)**

<b>T<sub>A</sub> (°C)</b>	<b>25</b>	<b>50</b>	<b>60</b>	<b>70</b>	<b>75</b>	<b>80</b>	<b>85</b>	<b>90</b>	<b>95</b>	<b>100</b>
P <sub>D</sub> (mW)	781	625	563	500	469	438	406	375	344	313
<b>T<sub>A</sub> (°C)</b>	<b>105</b>	<b>110</b>	<b>115</b>	<b>120</b>	<b>125</b>	<b>130</b>	<b>135</b>	<b>140</b>	<b>145</b>	<b>150</b>
P <sub>D</sub> (mW)	281	250	219	188	156	125	94	63	31	0

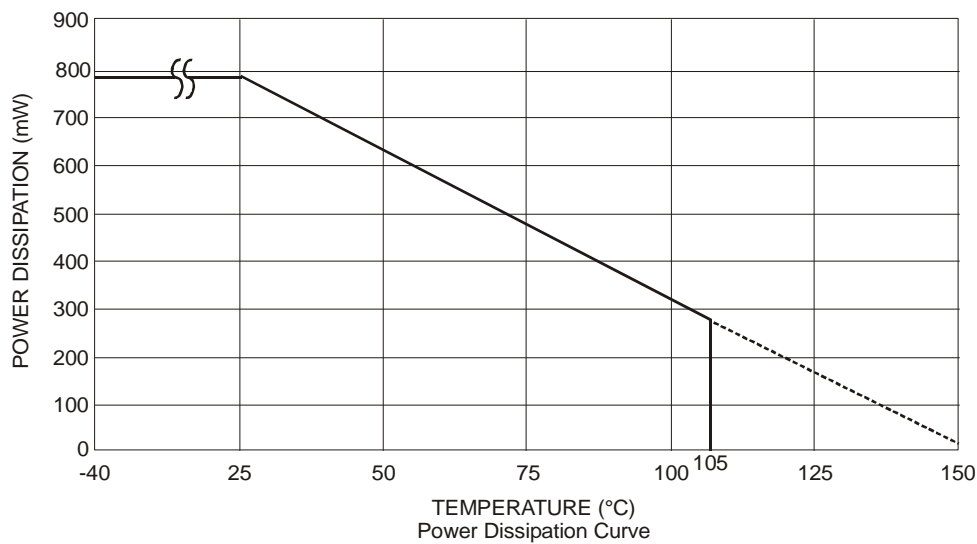

Notes: 10. U-DFN2020C-6 exposed pad soldered to minimum recommended landing pads (see Package Outline Dimension section) on a two-layer 2oz. copper FR4 PCB (1.6mm thickness) with no thermal vias in exposed PADs or any copper flood connecting to the landing pattern of the exposed pad.

**Ordering Information**

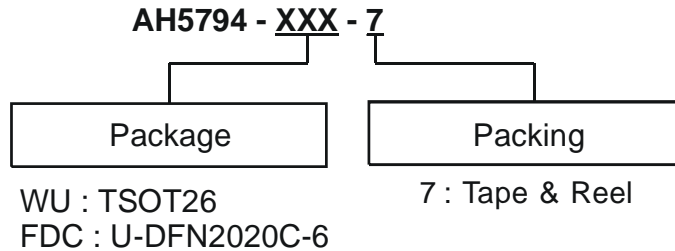

Device	Package Code	Packaging (Note 11 & 12)	7" Tape and Reel	
			Quantity	Part Number Suffix
AH5794-WU-7	WU	TSOT26	3000/Tape & Reel	-7
AH5794-FDC-7	FDC	U-DFN2020C-6	3000/Tape & Reel	-7

Notes: 11. Pad layout as shown on Diodes Inc. suggested pad layout document AP02001, which can be found on our website at <http://www.diodes.com/datasheets/ap02001.pdf>  
12. EU Directive 2002/95/EC (RoHS) & 2011/65/EU (RoHS 2) compliant. No purposely added lead. Halogen and Antimony free. Please visit our website at [http://www.diodes.com/products/lead\\_free.html](http://www.diodes.com/products/lead_free.html)

**Marking Information**

**(1) Package type: TSOT26**

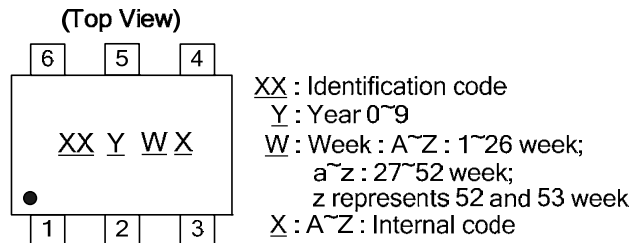

Part Number	Package	Identification Code
AH5794-WU-7	TSOT26	J4

**(2) Package type: U-DFN2020C-6**

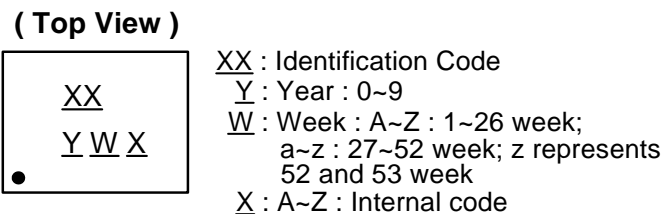

Part Number	Package	Identification Code
AH5794-FDC-7	U-DFN2020C-6	J4

**Package Outline Dimensions (All Dimensions in mm)**

**(1) Package type: TSOT26**

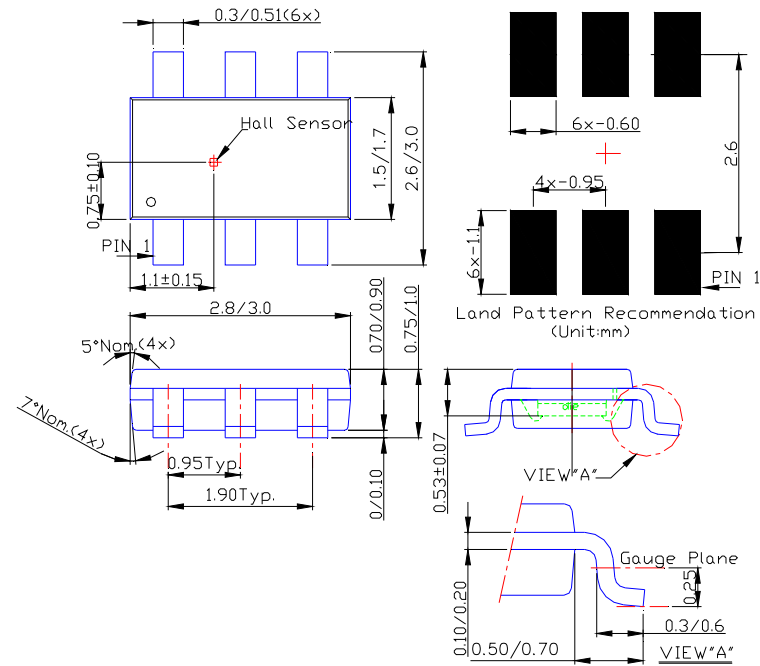

**(2) Package Type: U-DFN2020C-6**

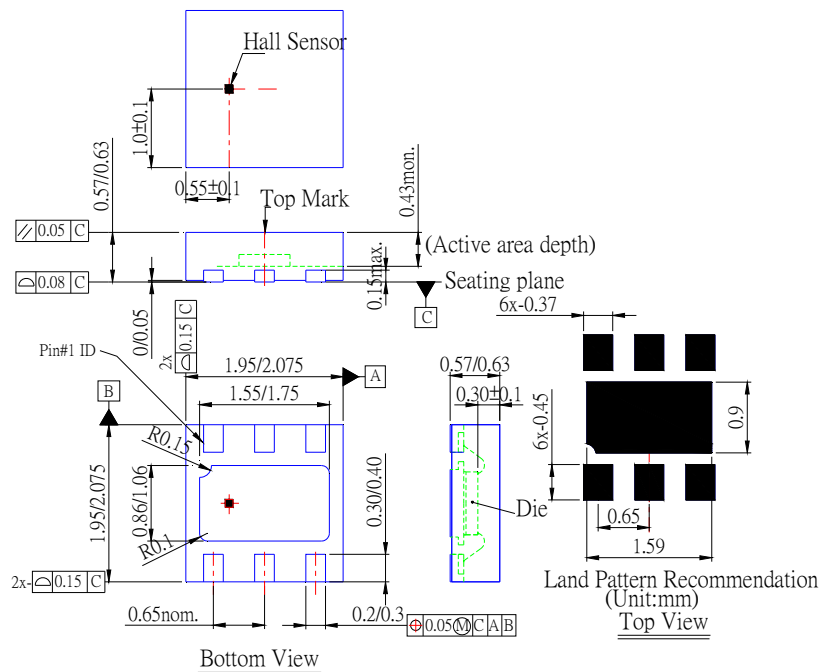

**Taping Orientation**

(1) Package Type: U-DFN2020C-6

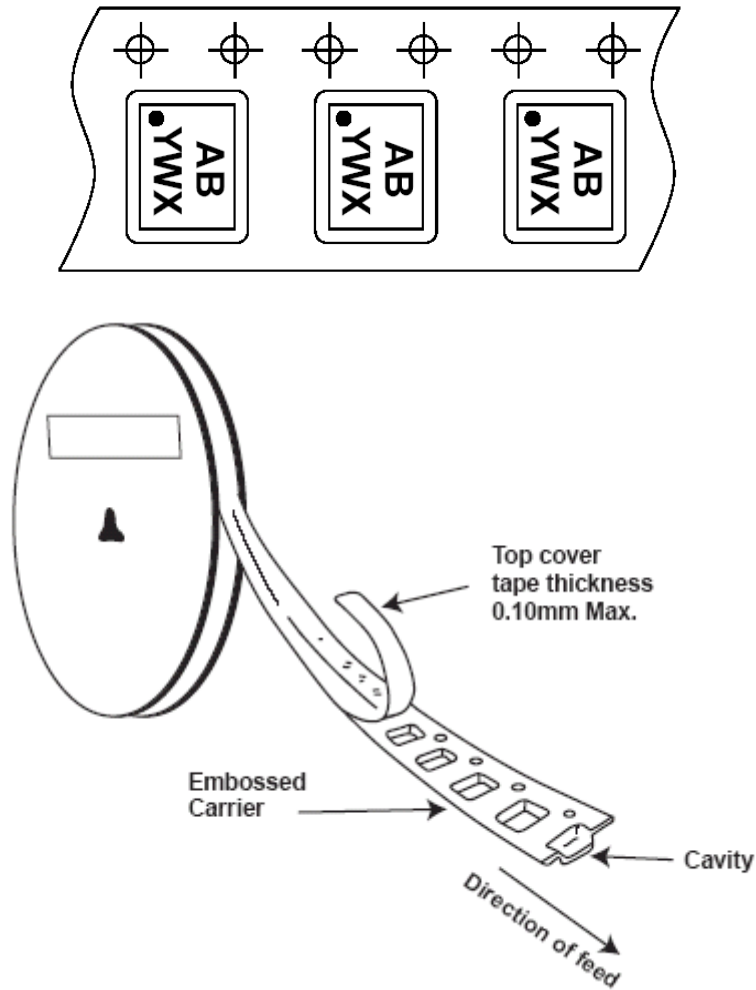

Notes: 11. The taping orientation of the other package type can be found on our website at <http://www.diodes.com/datasheets/ap02007.pdf>.

**IMPORTANT NOTICE**

DIODES INCORPORATED MAKES NO WARRANTY OF ANY KIND, EXPRESS OR IMPLIED, WITH REGARDS TO THIS DOCUMENT, INCLUDING, BUT NOT LIMITED TO, THE IMPLIED WARRANTIES OF MERCHANTABILITY AND FITNESS FOR A PARTICULAR PURPOSE (AND THEIR EQUIVALENTS UNDER THE LAWS OF ANY JURISDICTION).

Diodes Incorporated and its subsidiaries reserve the right to make modifications, enhancements, improvements, corrections or other changes without further notice to this document and any product described herein. Diodes Incorporated does not assume any liability arising out of the application or use of this document or any product described herein; neither does Diodes Incorporated convey any license under its patent or trademark rights, nor the rights of others. Any Customer or user of this document or products described herein in such applications shall assume all risks of such use and will agree to hold Diodes Incorporated and all the companies whose products are represented on Diodes Incorporated website, harmless against all damages.

Diodes Incorporated does not warrant or accept any liability whatsoever in respect of any products purchased through unauthorized sales channel.

Should Customers purchase or use Diodes Incorporated products for any unintended or unauthorized application, Customers shall indemnify and hold Diodes Incorporated and its representatives harmless against all claims, damages, expenses, and attorney fees arising out of, directly or indirectly, any claim of personal injury or death associated with such unintended or unauthorized application.

Products described herein may be covered by one or more United States, international or foreign patents pending. Product names and markings noted herein may also be covered by one or more United States, international or foreign trademarks.

**LIFE SUPPORT**

Diodes Incorporated products are specifically not authorized for use as critical components in life support devices or systems without the express written approval of the Chief Executive Officer of Diodes Incorporated. As used herein:

A. Life support devices or systems are devices or systems which:

1. are intended to implant into the body, or
2. support or sustain life and whose failure to perform when properly used in accordance with instructions for use provided in the labeling can be reasonably expected to result in significant injury to the user.

B. A critical component is any component in a life support device or system whose failure to perform can be reasonably expected to cause the failure of the life support device or to affect its safety or effectiveness.

Customers represent that they have all necessary expertise in the safety and regulatory ramifications of their life support devices or systems, and acknowledge and agree that they are solely responsible for all legal, regulatory and safety-related requirements concerning their products and any use of Diodes Incorporated products in such safety-critical, life support devices or systems, notwithstanding any devices- or systems-related information or support that may be provided by Diodes Incorporated. Further, Customers must fully indemnify Diodes Incorporated and its representatives against any damages arising out of the use of Diodes Incorporated products in such safety-critical, life support devices or systems.

Copyright © 2012, Diodes Incorporated

[www.diodes.com](http://www.diodes.com)

## X-ON Electronics

Largest Supplier of Electrical and Electronic Components

*Click to view similar products for [diodes](#) incorporated [manufacturer](#):*

Other Similar products are found below :

[1.5KE62A-T](#) [MMSZ5232BQ-13-F](#) [DMN2065UW-7](#) [AH3782-SA-7](#) [AP7365-39WG-7](#) [6A10-T](#) [AZ1117EH-5.0TRG1](#) [AZV3002S-13](#)  
[BAV116WSQ-7](#) [BCP5510TA](#) [BZT52C10-7-F](#) [BZT52C18-7-F](#) [PAM2863EV1](#) [SBRT25U60SLP-13](#) [LM2904AQM8-13](#) [GBPC1506](#)  
[BAS116-7-F](#) [BAT40V-7](#) [BAV20WS-7-F](#) [BAV23A-7-F](#) [BCR401UW6-7](#) [DMP4013LFG-7](#) [DMTH6009LK3Q-13](#) [SB560-T](#) [APX809-26SAG-](#)  
[7](#) [AL8807EV3](#) [B350A-13-F](#) [B560C-13-F](#) [AZV832MMTR-G1](#) [BAS70-05-7-F](#) [BAV23S-7-F](#) [BC847BW-7-F](#) [BC847CT-7-F](#) [BC847CW-7-F](#)  
[BC848C-7-F](#) [BC848CW-7-F](#) [BC858B-7-F](#) [BC858C-7-F](#) [BCP52TA](#) [BCX53TA](#) [BCX56TA](#) [B550C-13-F](#) [BAV20W-7-F](#) [BC847A-7-F](#)  
[BC847PN-7-F](#) [6A6-T](#) [BC857BT-7-F](#) [BS170FTA](#) [BCP5216TA](#) [BCP5310TA](#)